

# Nuestra experiencia hacia el futuro.



Aeroespacial



Aeronáutico

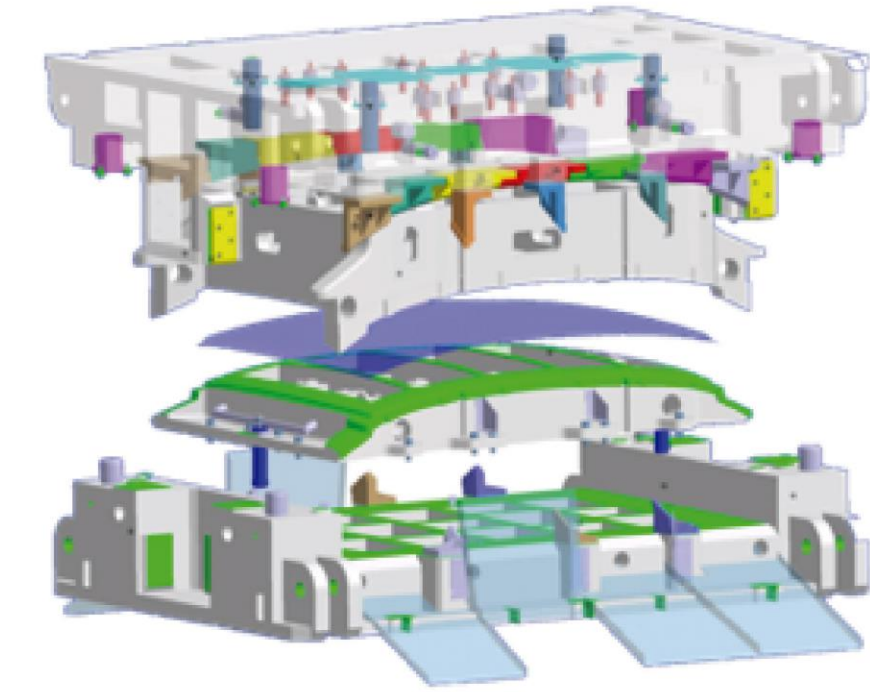

Herramental automotriz



Vehículo eléctrico

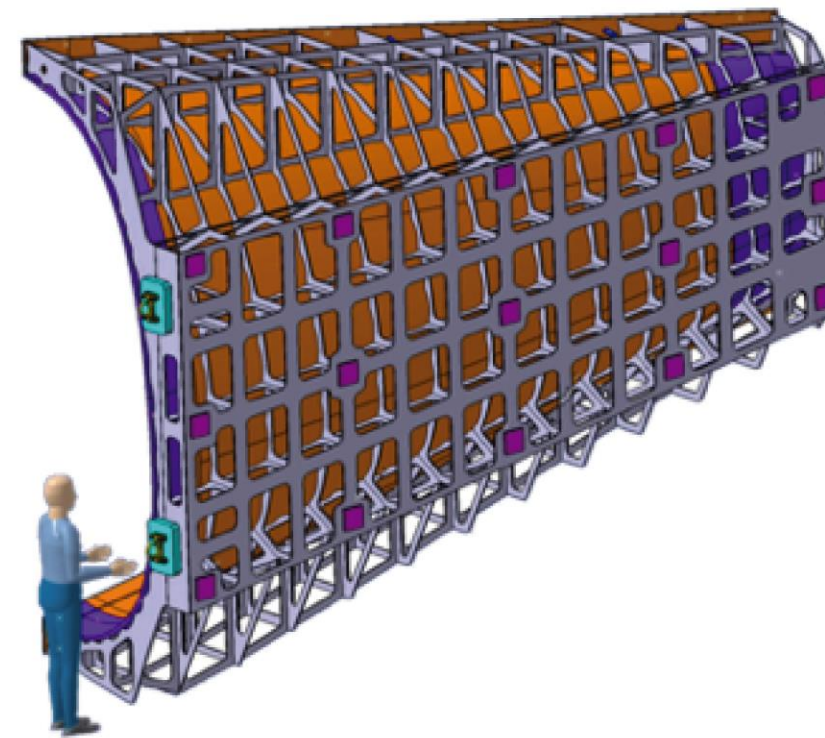

Herramental aeronáutico



Diseño y producción de CNC

# AERODINAMICA

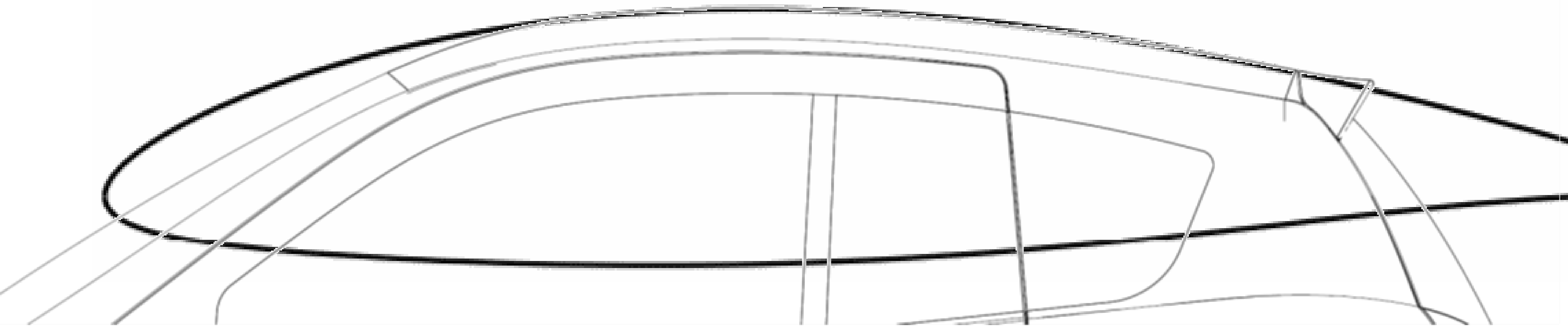

# CONCEPT 2D

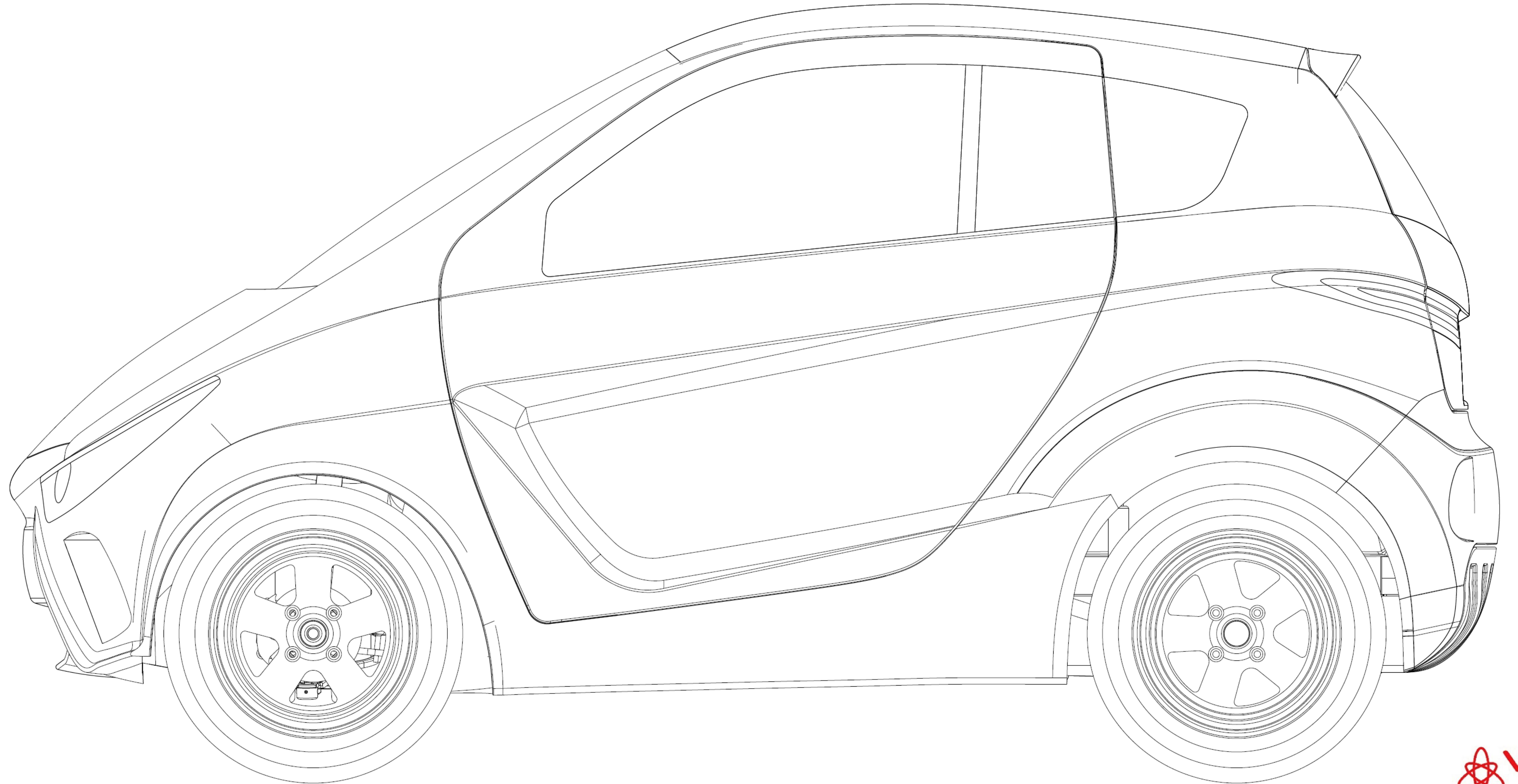

# MODELO 3D



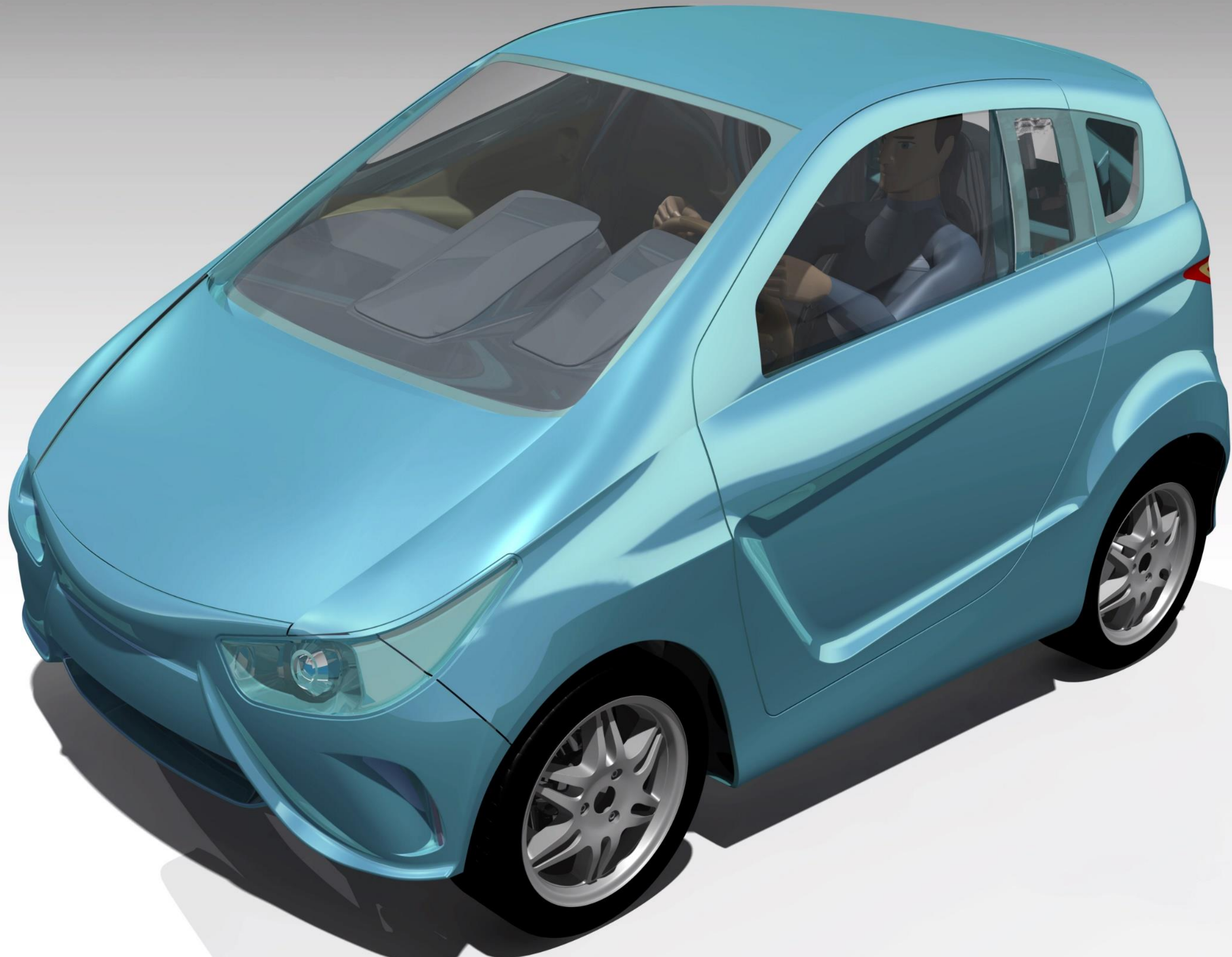

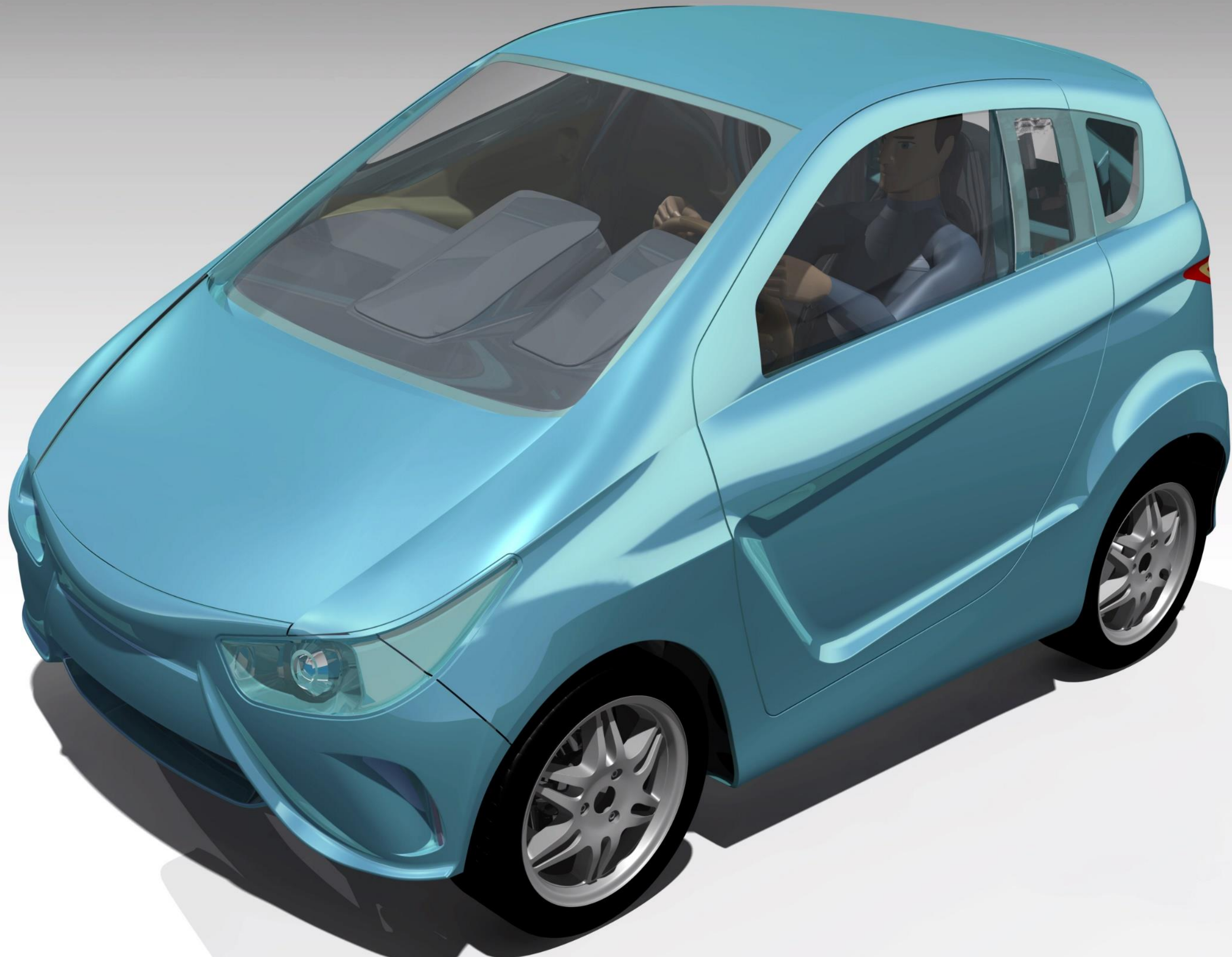









BRUNNEN  
Haus der 100 Biere





QUORUM  
Córdoba  
Hotel & Spa





# MODELO DE ELEMENTOS FINITOS

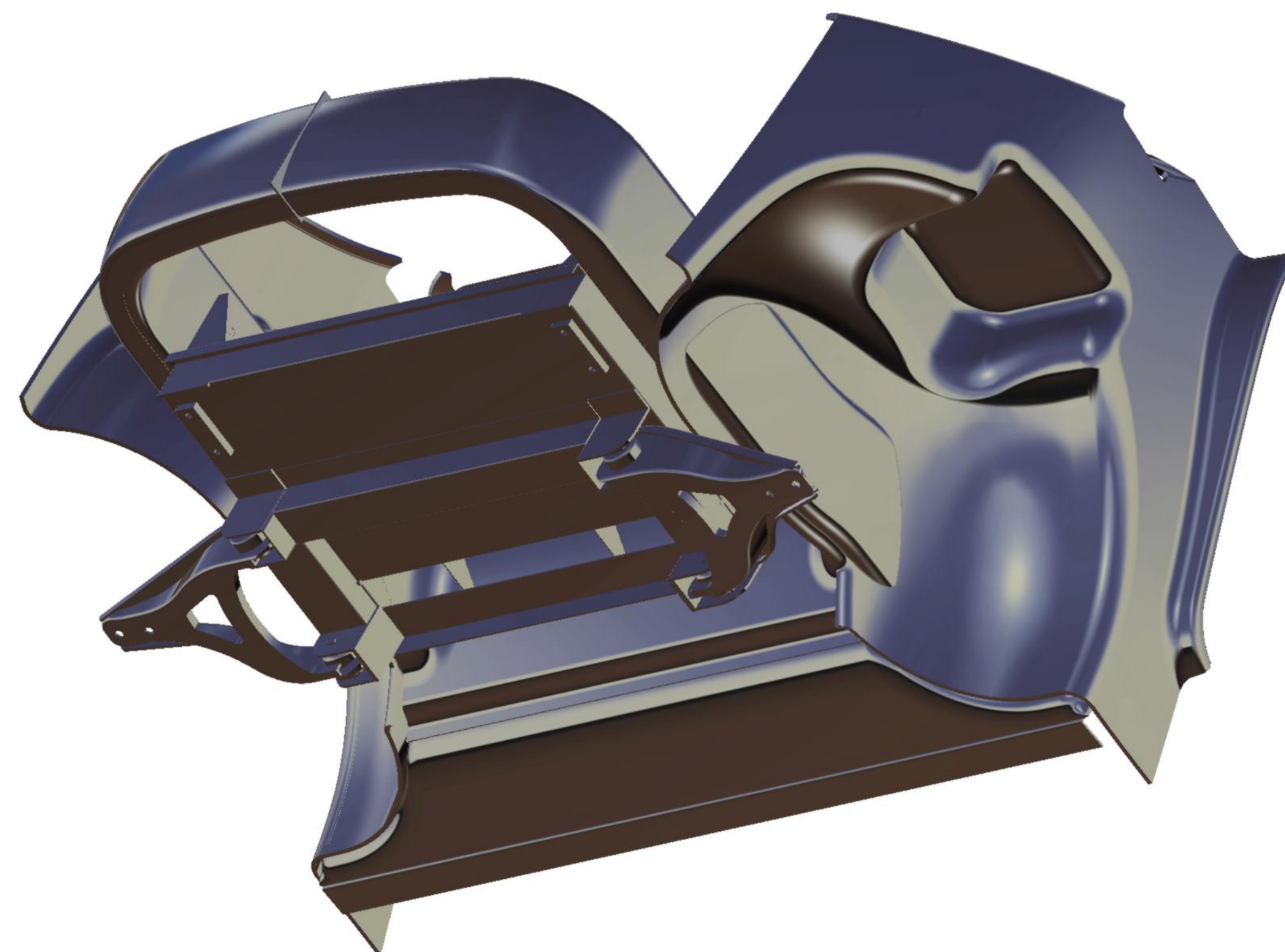
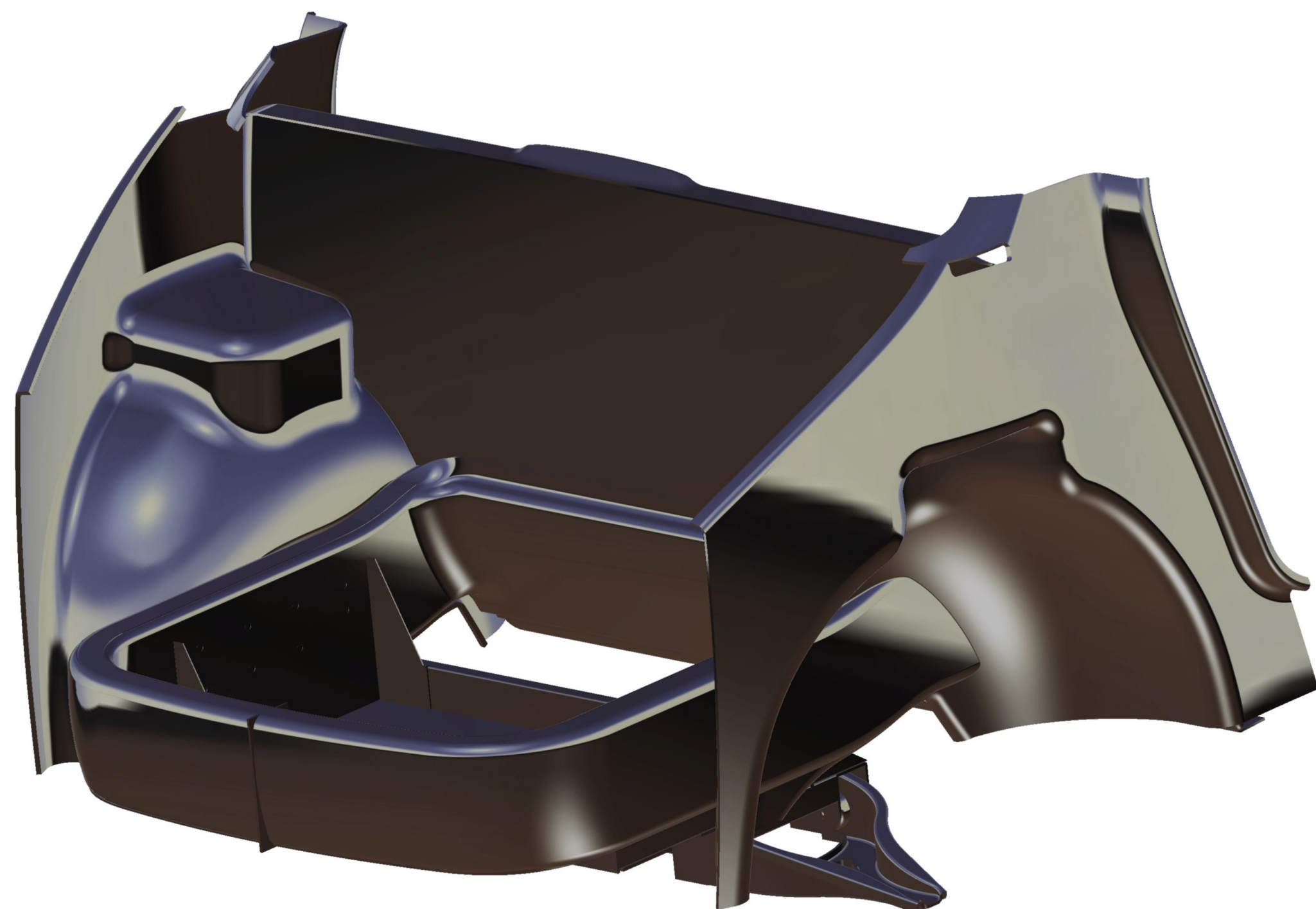



# MODELO DE ELEMENTOS FINITOS

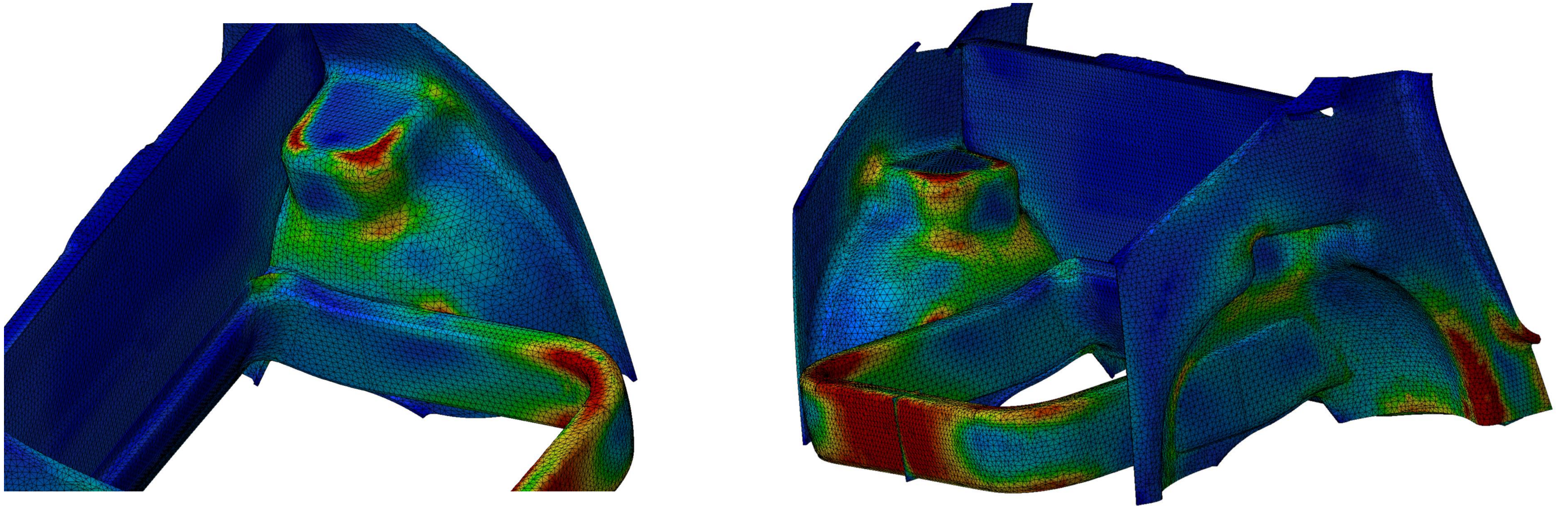

# MODELO DE ELEMENTOS FINITOS

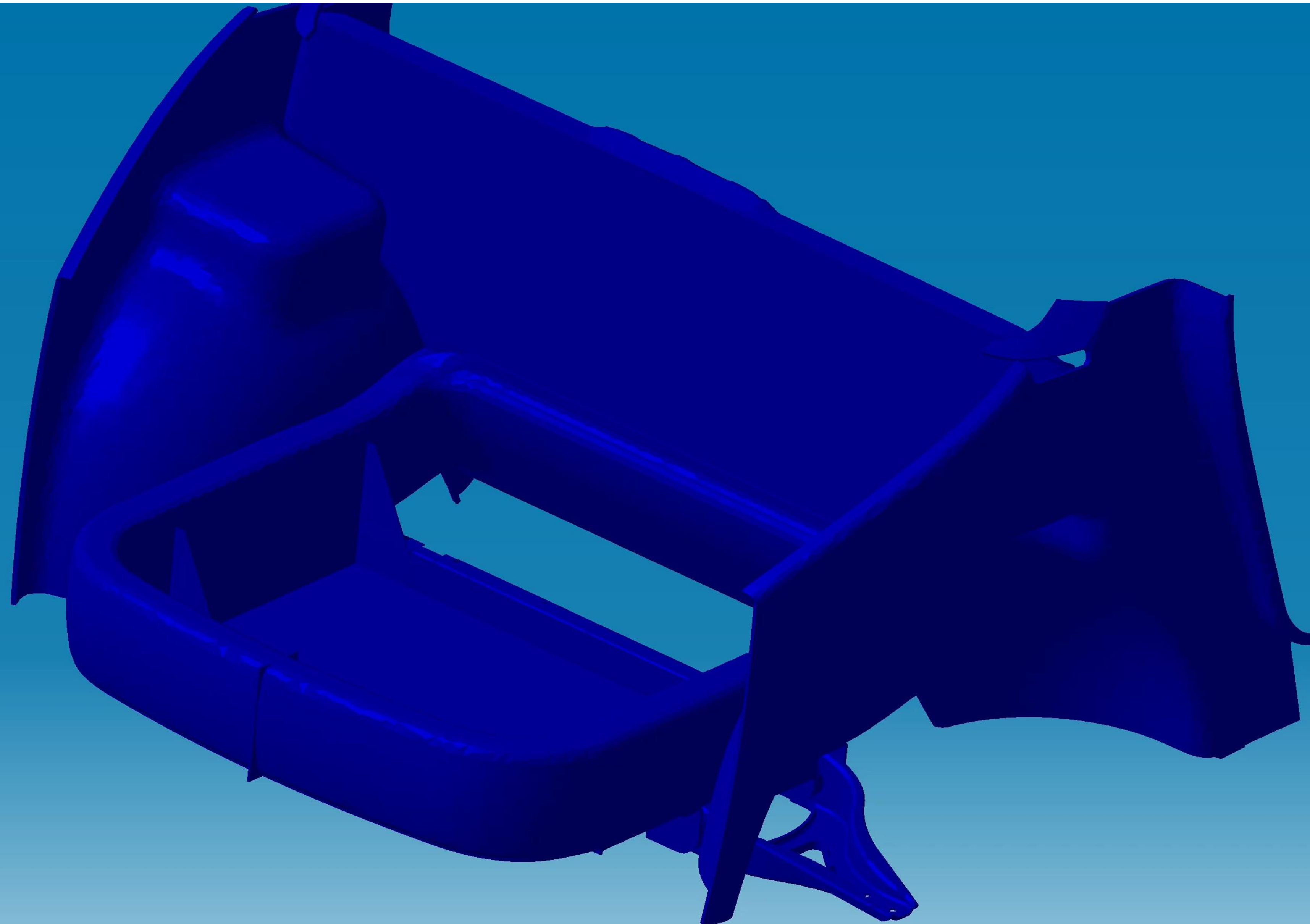

# MODELO DE ELEMENTOS FINITOS

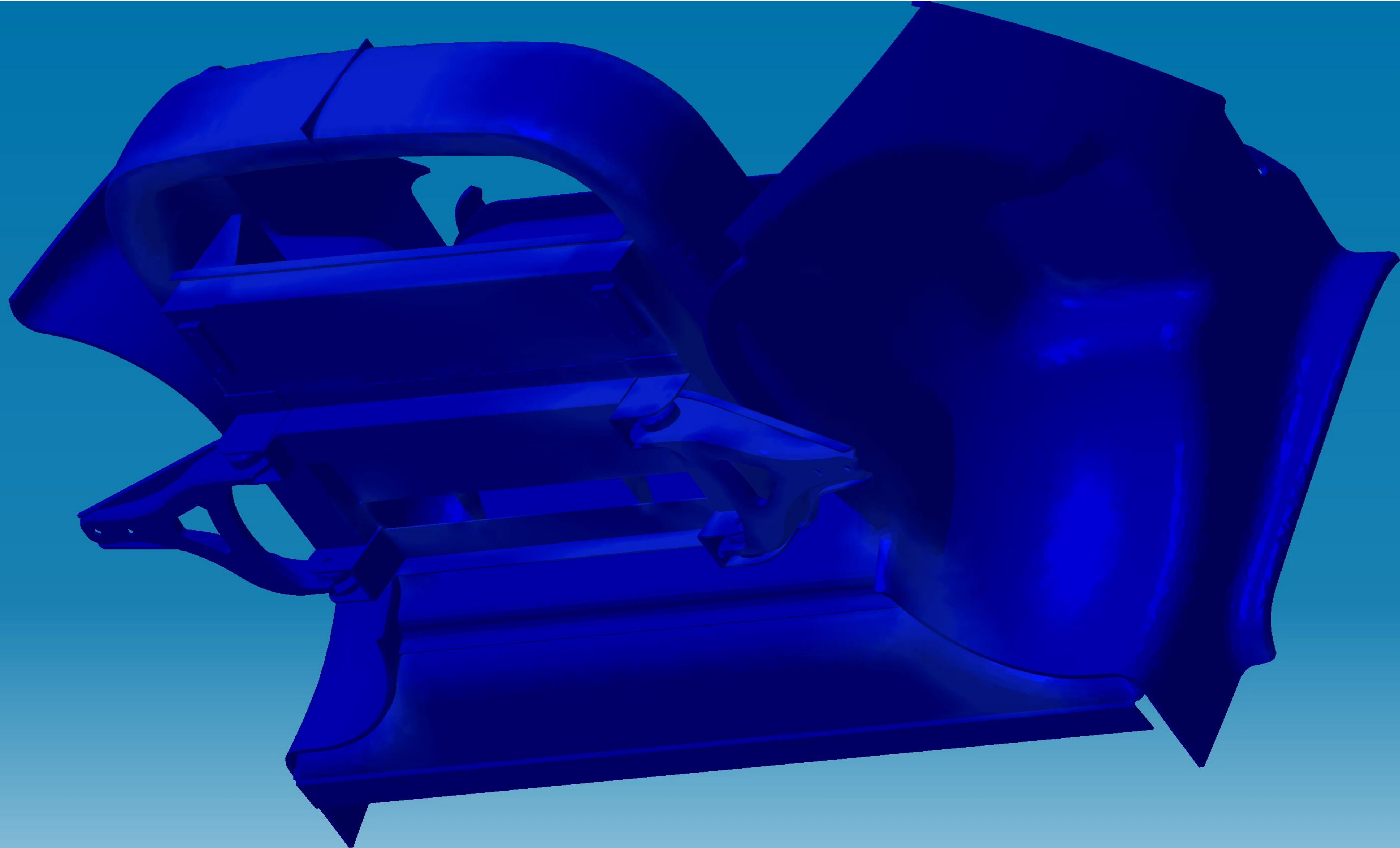

# Tecnología de vanguardia.

El nuevo **e1**, está dotado de las últimas tecnologías y gadgets para lograr un vehículo más económico, seguro y placentero.

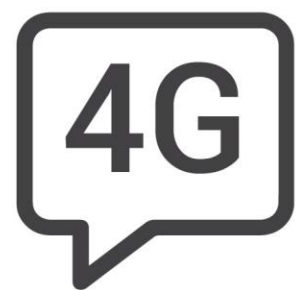

**LISTO**  
PARA ADOPTAR TECNOLOGÍA DE  
**MANEJO**  
**AUTÓNOMO**





## PANTALLA DE CONTROL

# SOFTWARE DE CONTROL DESDE CELULAR

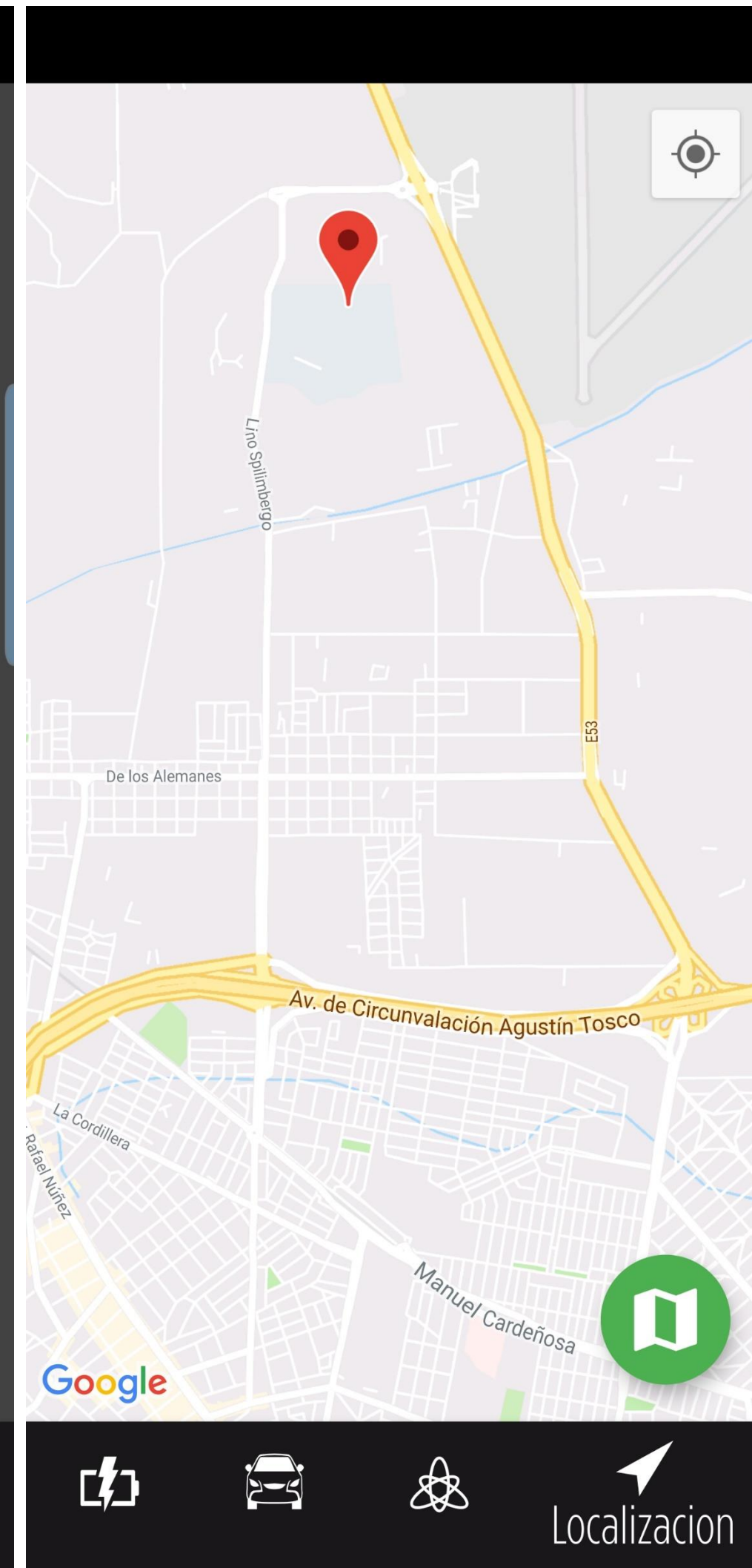
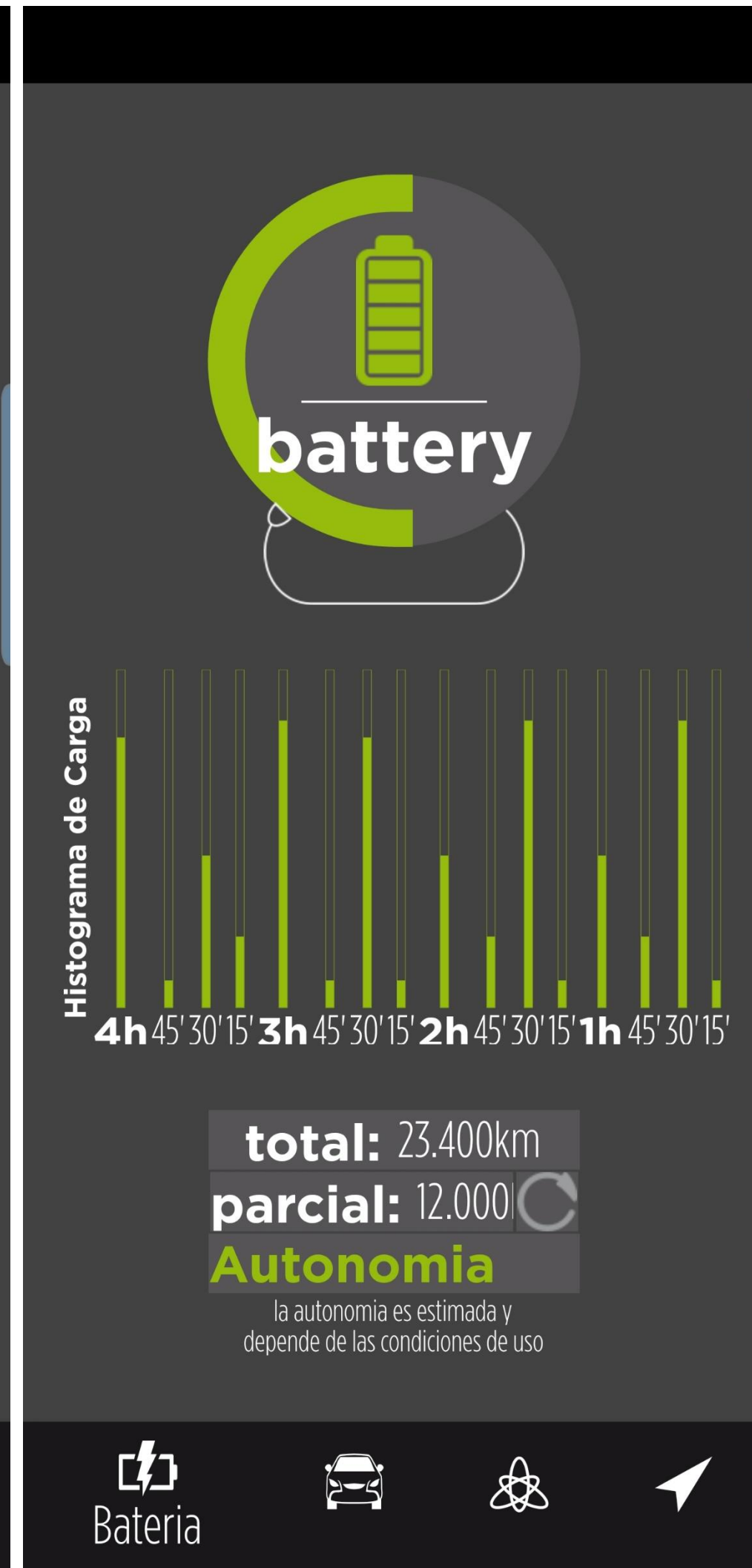
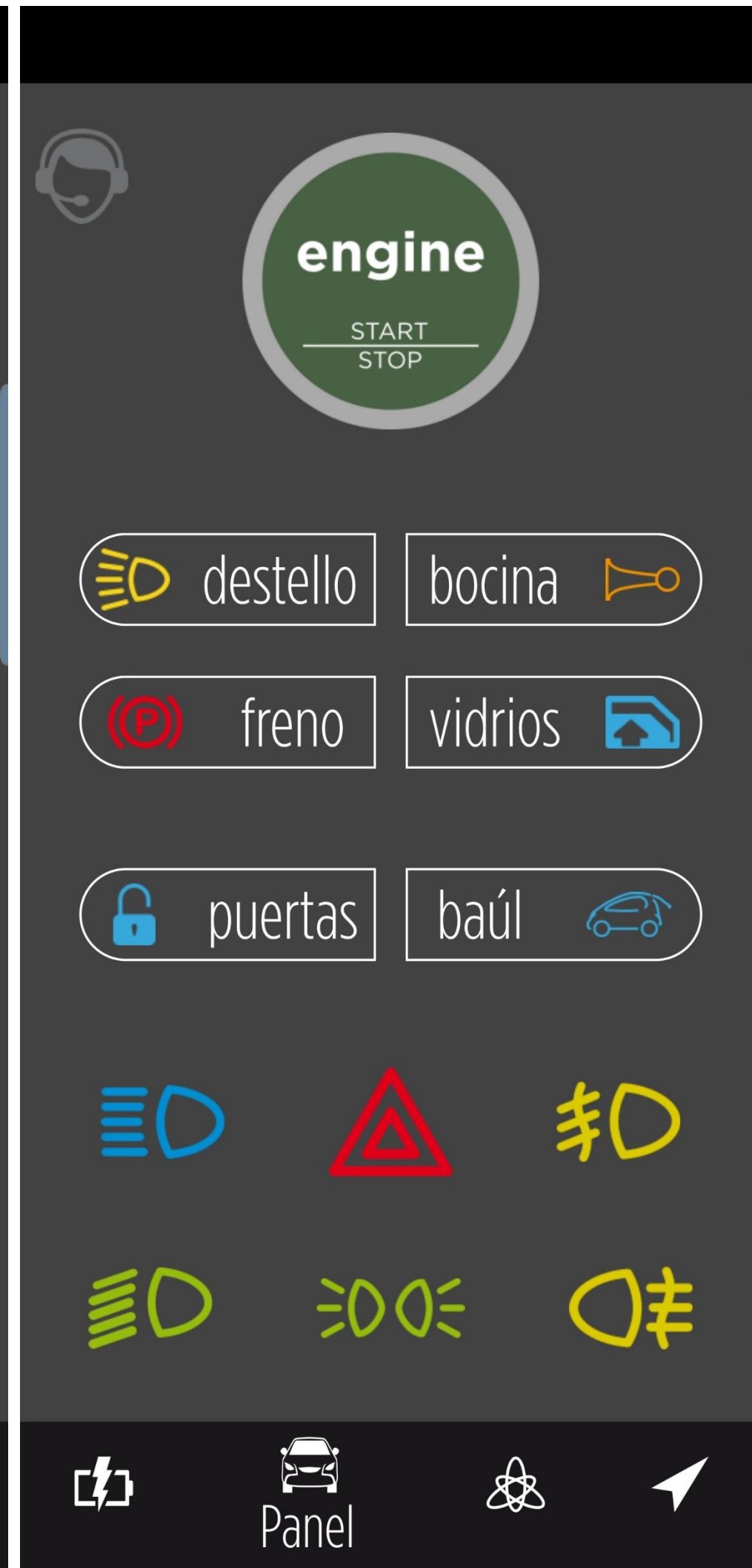
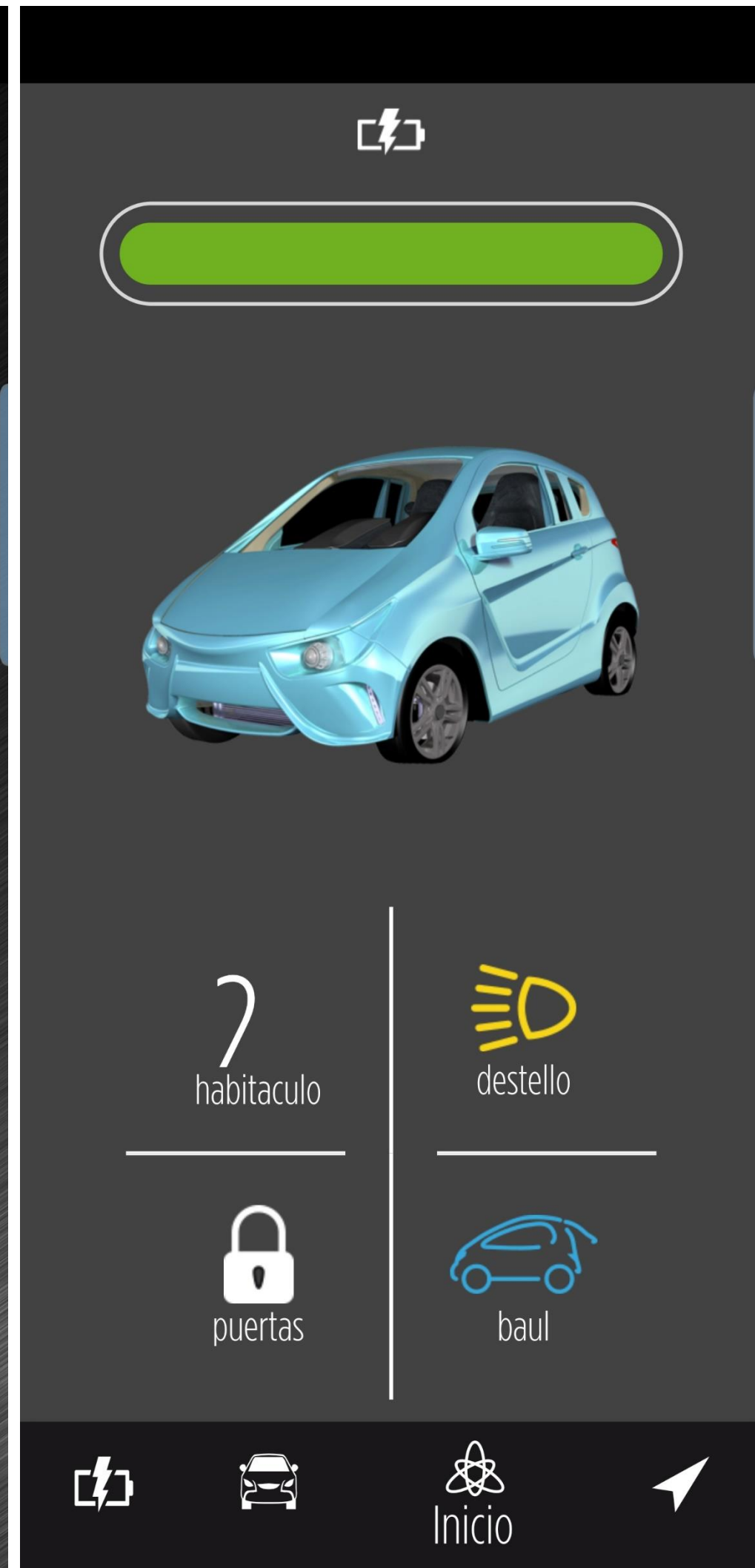



# Creado para la eficiencia, descubriilo.



Autonomía  
150 km

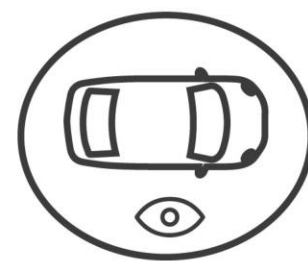

Visión  
360°



Vel. Máxima  
120 km/h



+ 2 adultos  
2 menores



Head-up  
display



Isofix



Frenos  
regenerativos

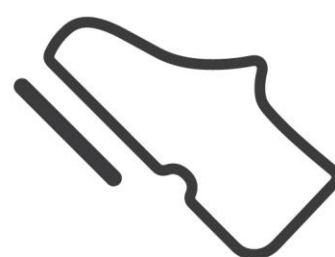

One foot  
drive



Alta capacidad  
de carga  
650 lts





# Eco - Friendly.

El cambio climático nos obliga a pensar en las futuras generaciones y construir un mañana mejor, representa un desafío permanente en nuestra forma de hacer las cosas.

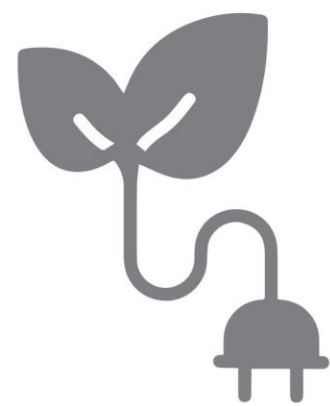

Energía limpia

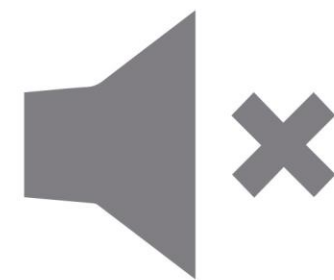

Completamente  
silencioso



No emite CO<sub>2</sub>





# Una visión con futuro

Situación actual

vs

Alternativa inteligente

vs

Futuro cercano

Modalidad



Mantenimiento



Combustible



Costo total



Tipo de uso



larga distancia



larga distancia

urbano



alternativas de transporte eficiente



urbano

Impacto ambiental

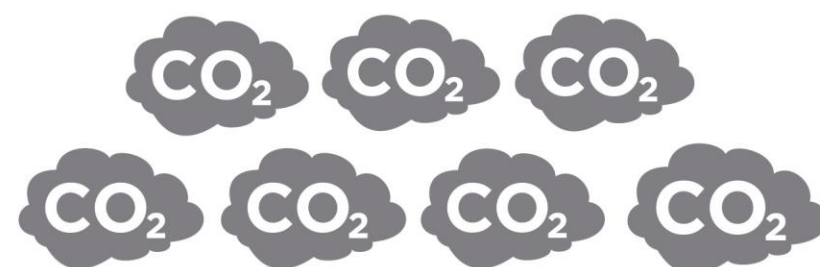

Uso de infraestructura vial

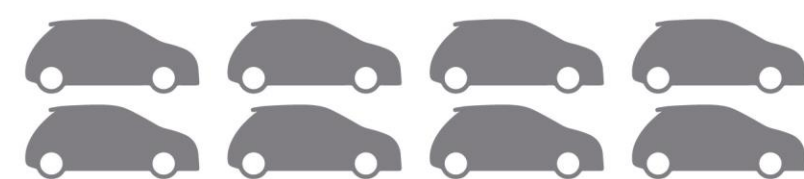



**GRACIAS**