



**UBA**  
1821 Universidad  
de Buenos Aires



# Agricultura extensiva en Argentina: producción y ambiente

## Encuentro de programas interdisciplinarios de la UBA

María Semmartin

Ciudad de Buenos Aires, 11 de diciembre de 2019



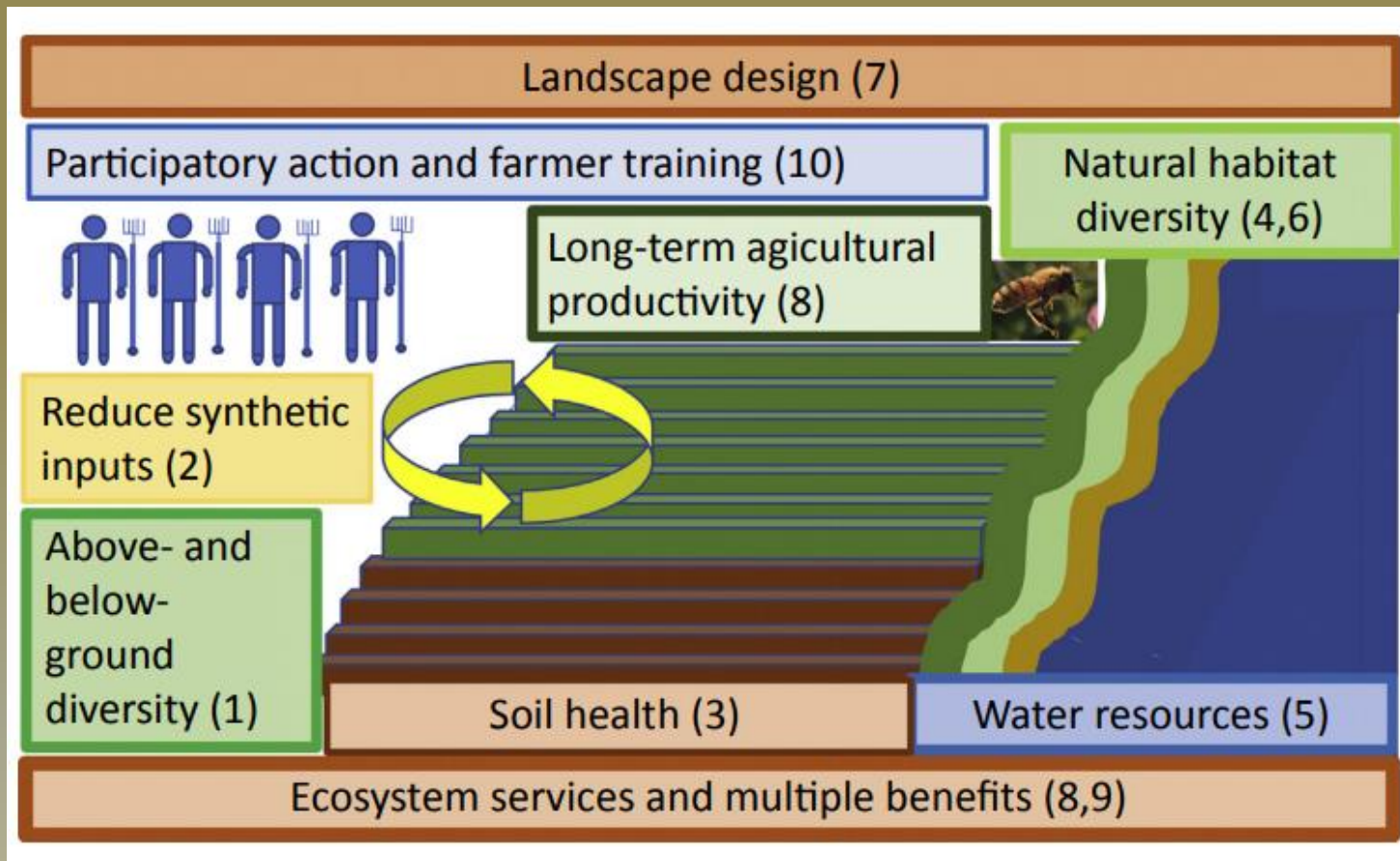

Garibaldi y colaboradores, 2019

Dos conceptos:

La agricultura extensiva afecta propiedades estructurales y funcionales de los ecosistemas.

La afectación ocurre a distintas escalas espaciales.

La agricultura extensiva afecta propiedades estructurales de los ecosistemas.

# BIO DIVERSIDAD



# BIO DIVERSIDAD



# BIO DIVERSIDAD



# Biodiversidad y estabilidad (resiliencia)

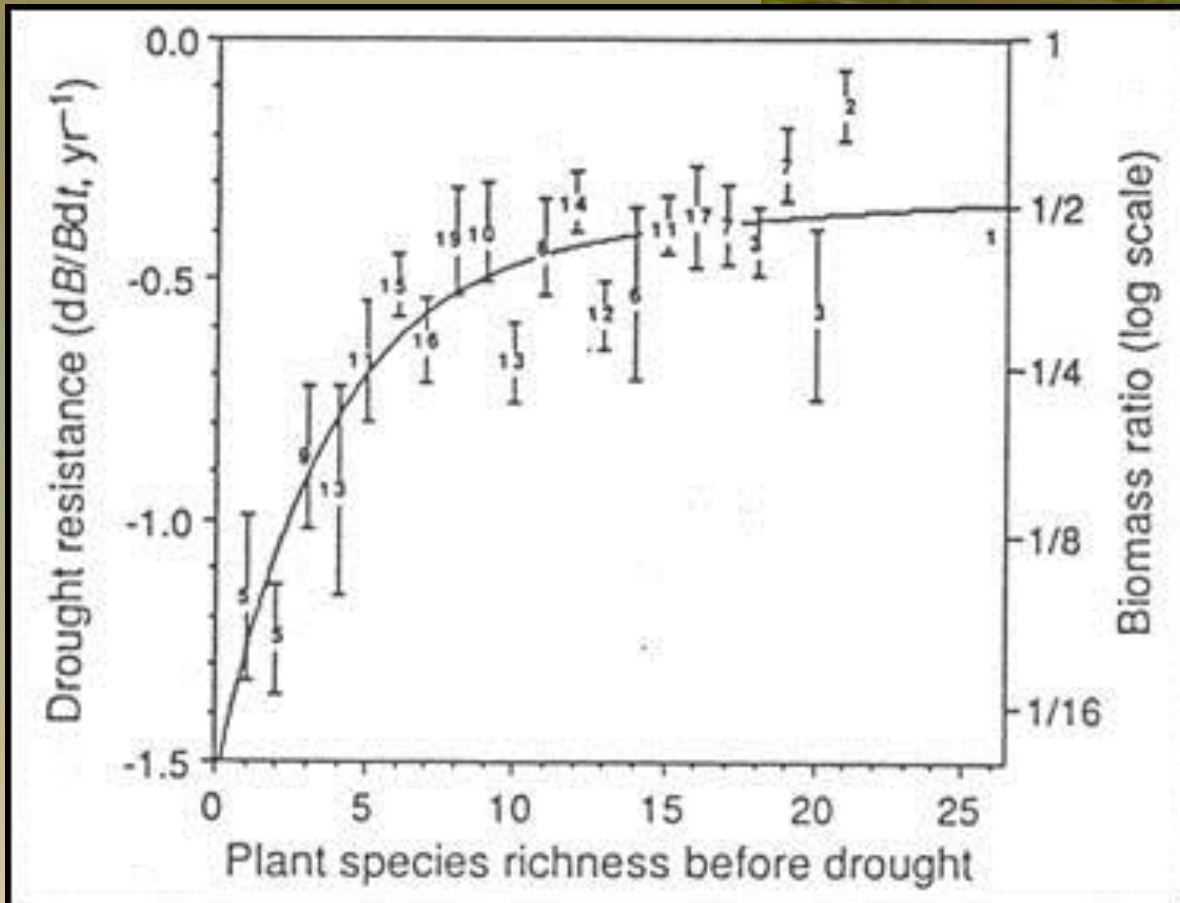

Tilman y Downing 1994

La agricultura extensiva afecta propiedades funcionales de los ecosistemas.

# ENERGÍA Y MATERIA

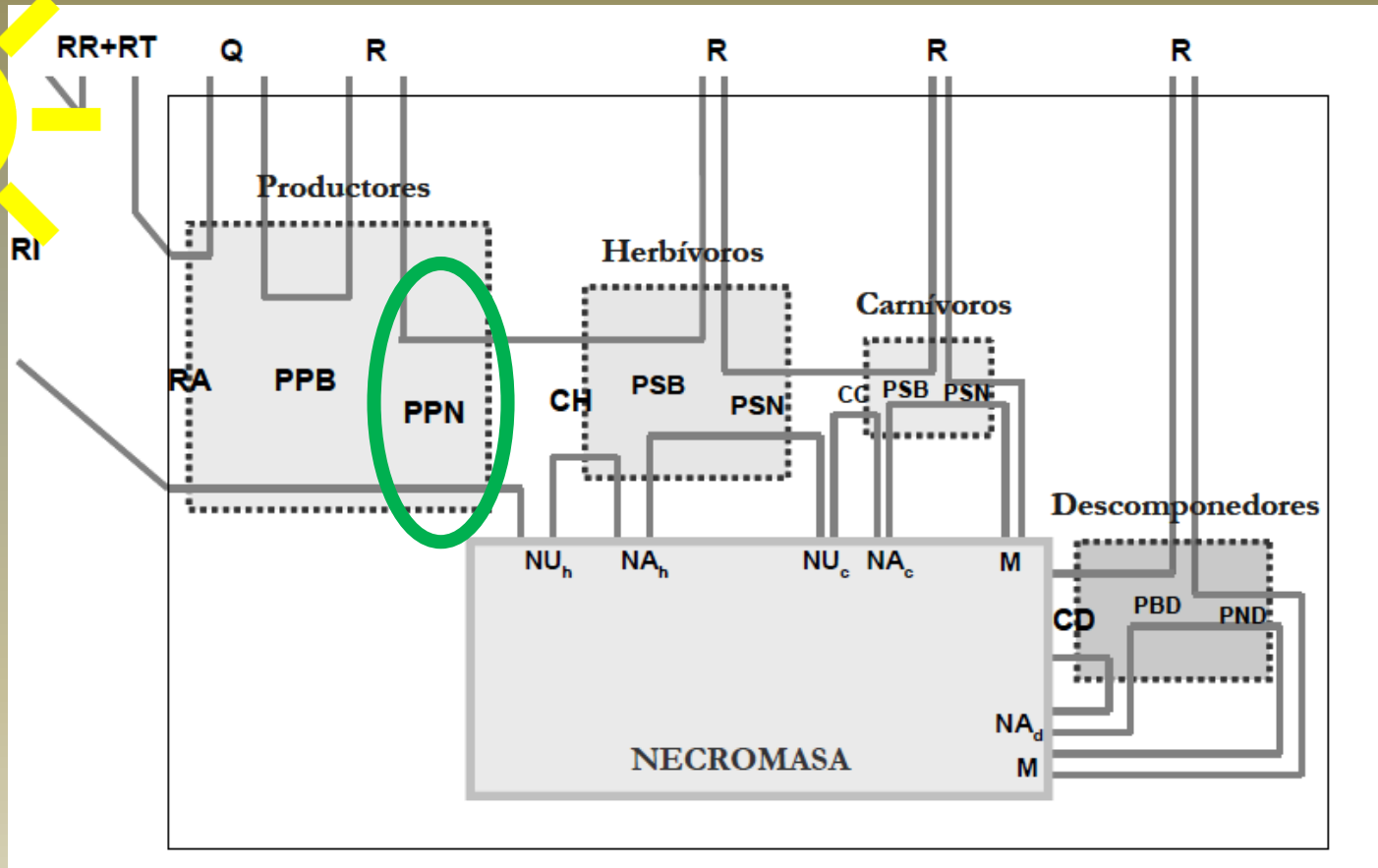
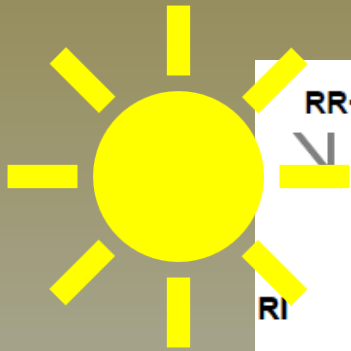





# ENERGÍA Y MATERIA

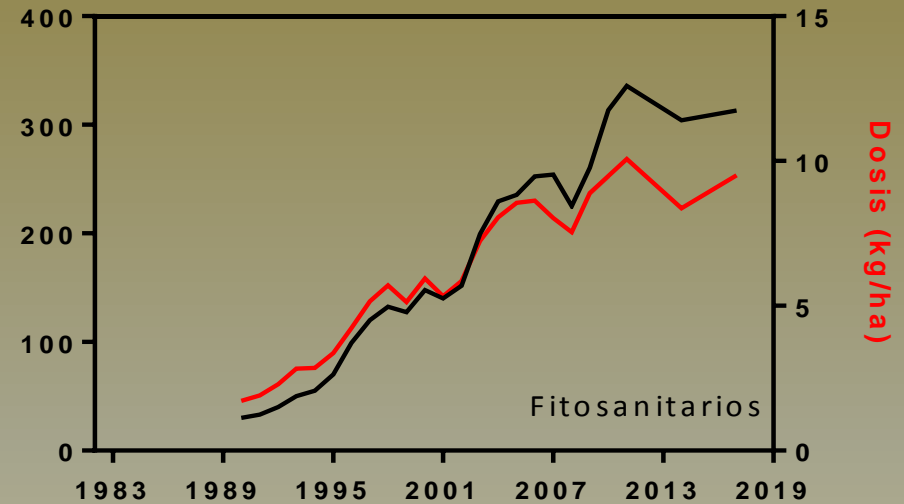
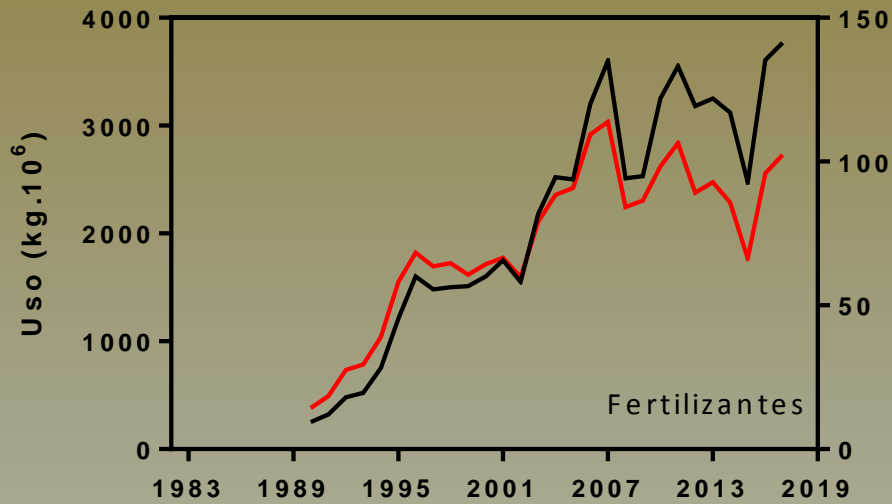

Ferraro y colaboradores, 2019



# Energía, materia y contaminación



Viglizzo y colaboradores, 2011

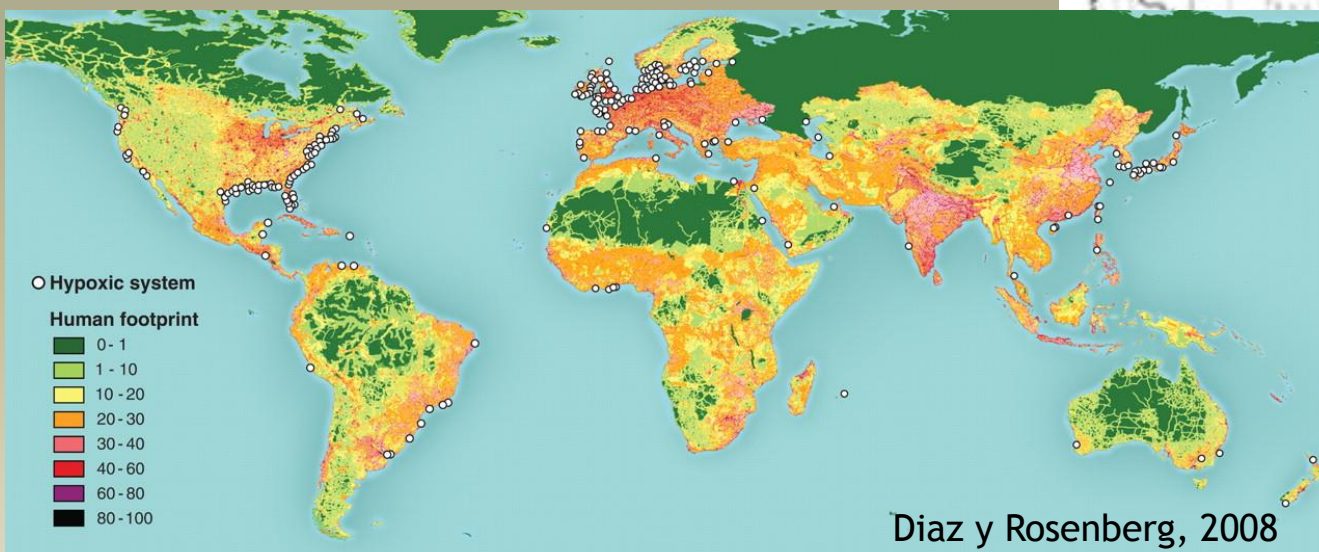

❖ La agricultura extensiva afecta propiedades estructurales y funcionales de los ecosistemas.

- Biodiversidad: de especies, comunidades y fisonomías.
- Concentración de la productividad primaria, fertilizantes, pesticidas.

❖ La afectación ocurre a distintas escalas espaciales.

- Lote, predio, paisaje, cuenca, región, planeta